

TOOLS CHECKLIST

- (A) Fixed Spanner
- (B) Mounting Screw
- (C) Small Screw
- (D) Click-In Mounting Plate
- (E) Click-In Tape Measure
- (F) Click-In Gauge

- Screwdriver
- Spirit Level

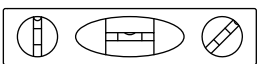
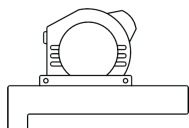
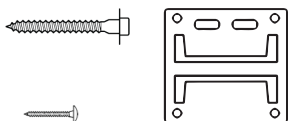
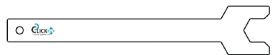

FOR INSTALLING WINDOWS WITH CLICK-IN



Read this before starting the installation:

- For the warranty to be valid, the product must be installed as per the instructions for use.
- Our wood and concrete screws are used for wooden and concrete buildings.
- Pre-drilling and wall plugs are required for installations in LECA and autoclaved aerated concrete.

1

Install at least 2 base screws at the bottom of the opening, depending on the size of the window.

(Not included in the Click-In system, so see the window manufacturer's instructions or standard.)

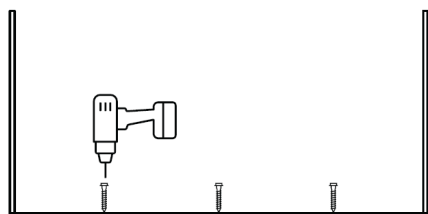

TIP
We recommend adjustable base screws (see image). Plastic or wooden washers can also be used.

Remember that screws and mounting plates should be installed centred under the window frame.

2

Adjust the base screws (or other accessories) with a spirit level.

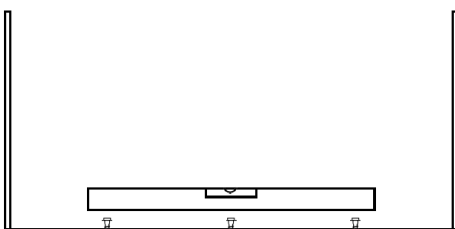

3

Install the Click-In mounting plate (D) in a suitable part of the frame using screw C. If the frame has grooves, use them. Remember that you can rotate the mounting plate (D) to adjust the window's depth in the opening.

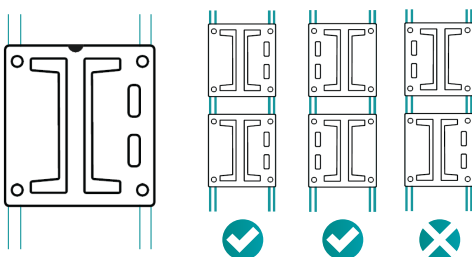

TIP
Remember to subtract the distance under the window and the wall = space for caulking.

All Click-In mounting plates (D) must be installed facing the same direction. It doesn't matter which.

4

Screw the mounting screws (B) into each side, as per the spacing instructions below. (For the number of screws, see the information box below.) For the screw placements in terms of depth, if the windows are to be flush with the wall, see the next illustration.

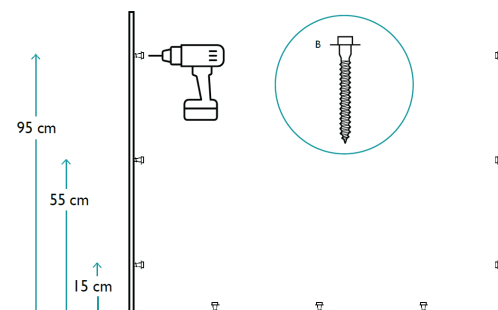

DETAILED INFORMATION

- The mounting screws (B) should be mounted with a cc of 40-50 cm.
- Window height 90 cm = 2 screws on each side.
- Window height 130 cm = 3 screws on each side.
- Window height 150 cm = 4 screws on each side

4A

If the windows are to be flush with the outside wall, use the gauge (F) to measure from the centre of the mounting plate to the outside of the window frame. (Use the marking on the outside edge of the mounting plate to centre.) Lock the gauge at the measurement for the mounting screw (B).

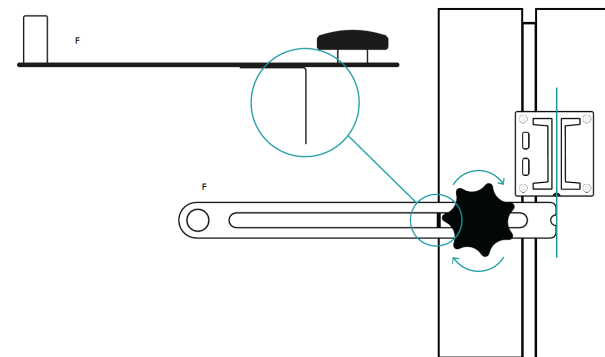

PLEASE
TURN OVER

INSTALLATION INSTRUCTIONS

5

Level all sides with a spirit level.

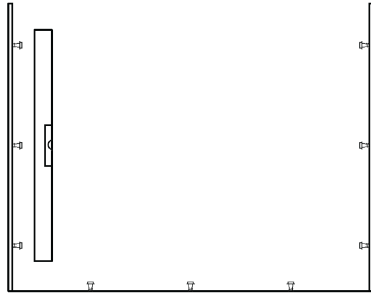

6

Measure the window width with the Click-In tape measure (E). The lip should be over the window edge. Lock the tape measure.

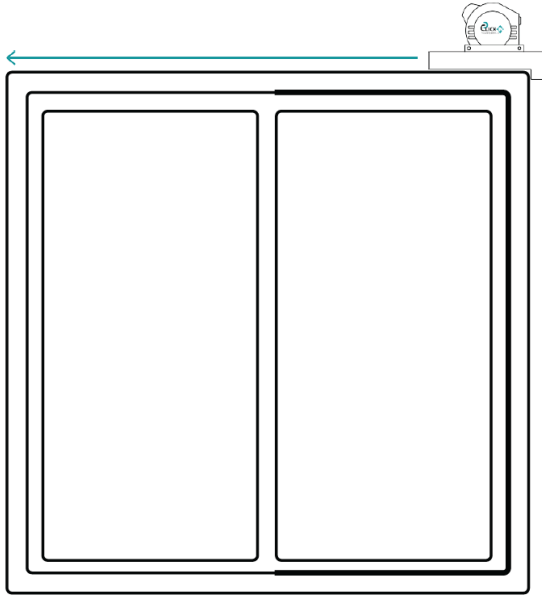

7

Place the locked tape measure (E) behind the screw head. If adjustments are necessary to fit the tape measure between the screws, adjust on the unlevelled side.

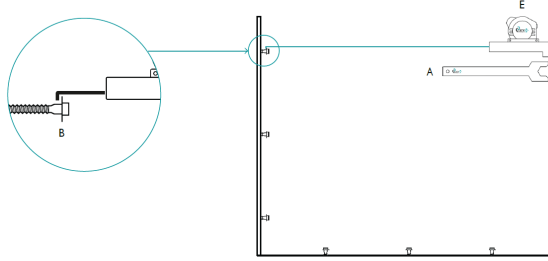

8

Rest the window at an angle on the base screws (or wooden/plastic washers) and tilt the window into place until you hear a "click" sound. Remember to place the window on the entire base first and then push the right and left sides in at the same time.

If the window requires lateral adjustment, use the fixed spanner (A) to adjust the mounting screws (B).

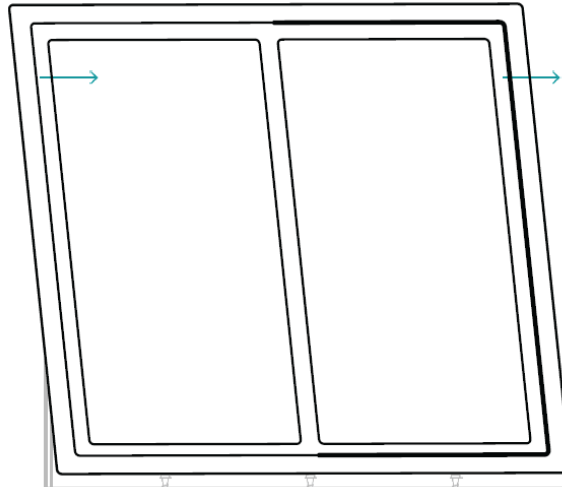

9

Once the window is in place, be sure to check that all Click-In fasteners have clicked into place. Make any adjustments with the fixed spanner (A).

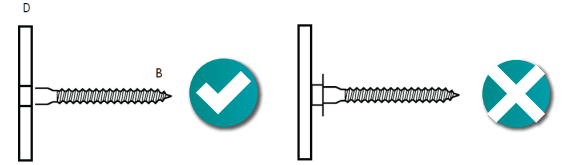

DONE IN A
CLICK!

